

# Flarm LED indicator

Version 1.12



LXNAV d.o.o. • Kidričeva 24a, 3000 Celje, Slovenia • tel +386 592 33 400 fax +386 599 33 522  
[info@lxnav.com](mailto:info@lxnav.com) • [www.lxnav.com](http://www.lxnav.com)

---

<b>1</b>	<b>Important Notices</b>	<b>3</b>
1.1	Limited Warranty	3
<b>2</b>	<b>Packing Lists</b>	<b>4</b>
<b>3</b>	<b>Basics</b>	<b>5</b>
3.1	<b>LXNAV FlarmLed display at a Glance</b>	<b>5</b>
3.1.1	LXNAV FlarmLed display features	5
3.1.2	Interfaces	5
3.1.3	Technical Data	5
<b>4</b>	<b>System Description</b>	<b>6</b>
4.1	<b>Description of Flarm Led Display</b>	<b>6</b>
4.1.1	Status LEDs	6
4.1.2	Horizontal direction LEDs	6
4.1.3	Vertical direction LEDs	6
4.1.4	Push Button	6
4.2	<b>Normal operation</b>	<b>7</b>
4.2.1	WARNING Modus:	7
4.2.2	NEAREST Modus:	7
4.2.3	Obstacle warning	7
4.2.4	Undirected PCAS warning	8
4.3	<b>Powering up FlarmLed display</b>	<b>8</b>
4.4	<b>Setting up FlarmLed display</b>	<b>8</b>
4.5	<b>Other indications</b>	<b>8</b>
4.5.1	Copying the IGC-file onto SD-card:	9
4.5.2	Running Flarm firmware update from SD-card	9
4.5.3	Copying the obstacle database from SD-card	9
4.5.4	Error codes from flarm	10
4.6	<b>Wiring</b>	<b>13</b>
4.6.1	FlarmLed pinout	13
4.6.2	FlarmMouse - FlarmLED	13
4.7	<b>Cutout</b>	<b>14</b>
<b>5</b>	<b>Revision History</b>	<b>15</b>

## 1 Important Notices

The LXNAV FlarmLed display is designed for VFR use only as an aid to prudent navigation. All information is presented for reference only.

Information in this document is subject to change without notice. LXNAV reserves the right to change or improve their products and to make changes in the content of this material without obligation to notify any person or organization of such changes or improvements.



A Yellow triangle is shown for parts of the manual which should be read carefully and are important for operating the LXNAV FlarmLed display



Notes with a red triangle describe procedures that are critical and may result in loss of data or any other critical situation.



A bulb icon is shown when a useful hint is provided to the reader.

### 1.1 Limited Warranty

This LXNAV FlarmLed display product is warranted to be free from defects in materials or workmanship for two years from the date of purchase. Within this period, LXNAV will, at its sole option, repair or replace any components that fail in normal use. Such repairs or replacement will be made at no charge to the customer for parts and labour, the customer shall be responsible for any transportation cost. This warranty does not cover failures due to abuse, misuse, accident, or unauthorized alterations or repairs.

THE WARRANTIES AND REMEDIES CONTAINED HEREIN ARE EXCLUSIVE AND IN LIEU OF ALL OTHER WARRANTIES EXPRESSED OR IMPLIED OR STATUTORY, INCLUDING ANY LIABILITY ARISING UNDER ANY WARRANTY OF MERCHANTABILITY OR FITNESS FOR A PARTICULAR PURPOSE, STATUTORY OR OTHERWISE. THIS WARRANTY GIVES YOU SPECIFIC LEGAL RIGHTS, WHICH MAY VARY FROM STATE TO STATE.

IN NO EVENT SHALL LXNAV BE LIABLE FOR ANY INCIDENTAL, SPECIAL, INDIRECT OR CONSEQUENTIAL DAMAGES, WHETHER RESULTING FROM THE USE, MISUSE, OR INABILITY TO USE THIS PRODUCT OR FROM DEFECTS IN THE PRODUCT. Some states do not allow the exclusion of incidental or consequential damages, so the above limitations may not apply to you. LXNAV retains the exclusive right to repair or replace the unit or software, or to offer a full refund of the purchase price, at its sole discretion. SUCH REMEDY SHALL BE YOUR SOLE AND EXCLUSIVE REMEDY FOR ANY BREACH OF WARRANTY.

To obtain warranty service, contact your local LXNAV dealer or contact LXNAV directly.

May 2013

© 2013 LXNAV. All rights reserved.

## **2 Packing Lists**

- FlarmLed display
- cable

## **3 Basics**

### **3.1 LXNAV FlarmLed display at a Glance**

FlarmLed display is a Flarm® compatible device, able to indicate horizontal and vertical direction of a threat. Nearby traffic is displayed visually and acoustically. It's extremely small size, low power consumption, and has very bright bicolor LED's.

#### **3.1.1 LXNAV FlarmLed display features**

- extremely bright bicolor LEDs
- pushbutton, to adjust beep volume
- near mode function
- adjustable baud rate
- slave mode
- Low current consumption

#### **3.1.2 Interfaces**

- Serial RS232 input/output
- pushbutton
- 12 bicolor LEDs for direction
- 5 LEDs for vertical angle
- 3 LEDs for GPS, Rx and Tx indication

#### **3.1.3 Technical Data**

- Power input 3.3V DC
- Consumption 10mA@12V (120mW)
- Weight 10 g
- 42mm x 25mm x 5mm

## 4 System Description

### 4.1 Description of Flarm Led Display

Flarm led consist of 5 main parts:

- Status LEDs
- Horizontal direction LEDs
- Vertical direction LEDs
- Push button
- Beeper



#### 4.1.1 Status LEDs

Status LEDs indicates if flarm receiver receives any data, transmits data and GPS status.

GPS status led has 3 different modes:

- Fast blinking mode, means, that FlarmLed does not receive anything over serial bus (probably needs to set correct baud rate)
- Slow blinking means, that GPS status is BAD
- Solid light means, that GPS status is OK.

#### 4.1.2 Horizontal direction LEDs

12 horizontal LEDs are indicating the direction of threat.

#### 4.1.3 Vertical direction LEDs

5 LEDs are describing vertical angle of threat divided by 14°

#### 4.1.4 Push Button

With push button we can adjust volume of beep, turning on/off near mode or adjust initial settings of FlarmLed display.

## 4.2 Normal operation

In normal operation with short press, we can cycle between three different volumes (Low, Medium and High). With long press, is enabled or disabled near mode. Switching of mode is also visually supported with moving light around circle. Red moving light means, that near mode is enabled, yellow moving light means, that near mode is disabled.

### 4.2.1 WARNING Modus:

**WARNING Mode** will activate a red blinking diode, if another glider equipped with Flarm will be close and a prediction for a **collision** risk is calculated. An audio warning will be also executed. Higher collision risk will increase blinking frequency and audio beep rate. The warnings are classified into three levels (See Flarm manual for details on [www.flarm.com](http://www.flarm.com))

- First level approximately **18 seconds** before predicted collision
- Second level approximately **13 seconds** before predicted collision
- Third level approximately **8 seconds** before predicted collision

### 4.2.2 NEAREST Modus:

Will show the direction to the nearest glider, which's position is inside of radio range. **One** yellow LED will light **permanently** and there will **be no audio**. The unit will change over to Warning Mode **automatically, if warning** criteria will be fulfilled and will continue in NEAREST after collision risk will disappear.



Near mode works only when you are moving. On ground, you cannot see nearest target.

### 4.2.3 Obstacle warning

An obstacle warning will be activated, if an obstacle is to be found in the front of the glider and a collision risk is predicted. The warning is shown with two red LEDs, symmetrical around the 12 o'clock LED at 10 and 2, they alternate with those at 11 and 1. As we approach to the obstacle the frequency of the alternation increases.



### 4.2.4 Undirected PCAS warning

Is the FlarmLED connected to a device, which also translates transponder signals with ADS-B data into Flarm warnings, you will receive them in the same logic as above. Transponder signals without ADS-B data contain no direction for the thread therefore you will get an undirected warning with the following alternating signals:

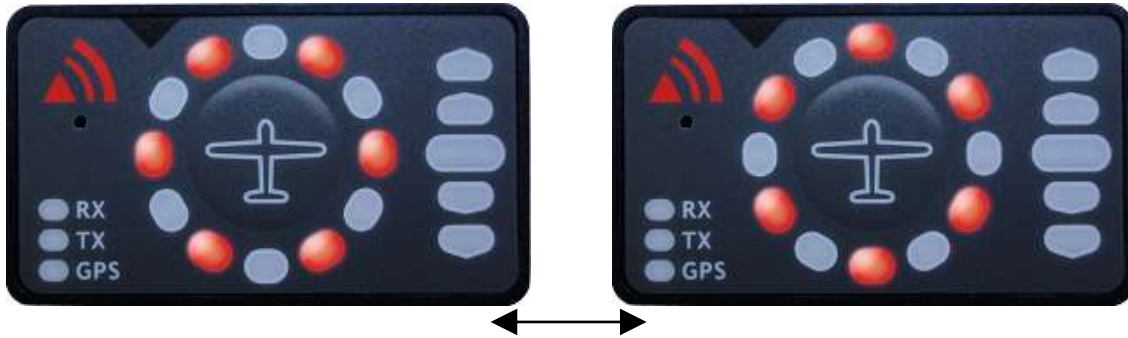

### 4.3 Powering up FlarmLed display

LXNAV FlarmLed is powered directly from flarm device with 3.3Volts. When gets power it passes boot up sequence with test of all LEDs and short beep, shows version of FlarmLed display firmware (yellow led indicated major version, red indicates minor version).

### 4.4 Setting up FlarmLed display

If we hold push button, during power on, LXNAV FlarmLed will go in setup mode, where is possible to adjust following settings:

- Communication speed
- Master/Slave mode
- Enable/disable PCAS warnings

Yellow led indicates mode that we are setting, Red LEDs indicates setting of each mode.

		Red 12	Red 1	Red 2	Red 3	Red 4	Red 5
<b>Yellow 12</b>	Baud rate	4800bps	9600bps	19200bps	38400bps	57600bps	115200bps
<b>Yellow 1</b>	Master/Slave	Master	Slave	/	/	/	/
<b>Yellow 2</b>	PCAS	Enabled	Disabled	/	/	/	/

This setup is prepared because some FLARMs are set to different baud rates, so it's necessary also to set FlarmLed to same baud rate. Normally Flarm default baud rate is 19200bps, on that setting is also set FlarmLed display.

Master/Slave option is usable only if we have connected to flarm more than one Flarm led display. In that case display can interfere each other. Only one can be set to Master, all other must be set to slaves.

Last setting enables or disables PCAS warnings, which might be sometimes very annoying.

### 4.5 Other indications

The FlarmLED Display can indicate some further statuses:



#### 4.5.1 Copying the IGC-file onto SD-card:



#### 4.5.2 Running Flarm firmware update from SD-card











#### 4.5.3 Copying the obstacle database from SD-card



### 4.5.4 Error codes from flarm

Error code	Description	Functionality	Display
0x11	Fault: Software out of date (needs GPS reception)	No operation	
0x12	Fault: Software integrity violation (only on IGC-units)	No operation	
0x21	Fault: Low Voltage	No operation	
0x31	Fault: Internal GPS communication	No operation	
0x32	Fault: Faulty GPS configuration	No operation	
0x41	Fault: Internal radio communication	No operation	
0x51	Fault: General internal communication	No operation	
0x61	Fault: Flash memory	No operation	

0x71	Fault: Pressure sensor	No operation	
0xF1	Fault: Other fault	No operation	
0x81	Indication: No obstacle data bank	Operation possible	
0x91	Indication: Flight recording not possible	Operation possible	
0x93	Indication: Engine-noise recording not possible (only on IGC-units)	Operation possible	
0xA1	Indication: Error with SD-card configuration file	Operation possible	
0x2a	Indication: Transponder receiver mode C/S/ADS-B unserviceable.	Operation possible	
82	Indication: Obstacle database out of date (alarms are still generated).	Operation possible	
B1	Indication: Invalid obstacle database licence.	Operation possible	

B2	Indication: Invalid IGC feature licence.	Operation possible	
B3	Indication: Invalid AUD feature licence.	Operation possible	
B4	Indication: Invalid ENL feature licence.	Operation possible	
B5	Indication: Invalid RFB feature licence.	Operation possible	
B6	Indication: Invalid TIS feature licence.	Operation possible	
100	Indication: Generic error.	Operation possible	
101	Indication: Flash File System error.	Operation possible	
110	Indication: Failure updating firmware of external display (e.g., Butterfly).	Operation possible	
120	Indication: Device is operated outside designated region. Radio performance may be degraded.		

## 4.6 Wiring

### 4.6.1 FlarmLed pinout



Pin number	Description
1	N.C.
2	(output) Transmit from LXNAV FLARM LED RS232 Level
3	(input) Receive to LXNAV FLARM LED RS232 Level
4	Ground
5	3.3V power supply (input)
6	N.C.

### 4.6.2 FlarmMouse - FlarmLED

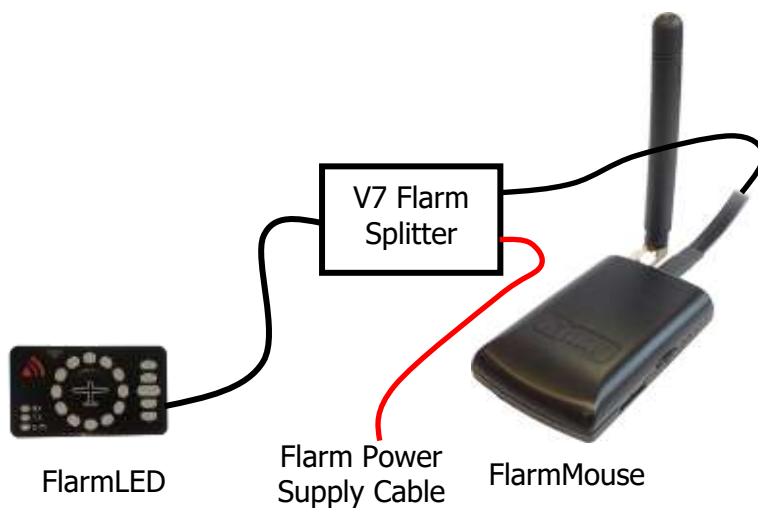

**4.7 Cutout**

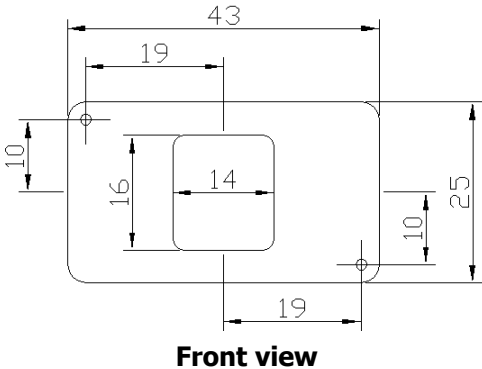

## 5 Revision History

May 2013	Initial release of owner manual
October 2013	Added chapters 4.2 and 4.
March 2014	Modified chapter 4.4
May 2014	Added error codes